

Braided Fence

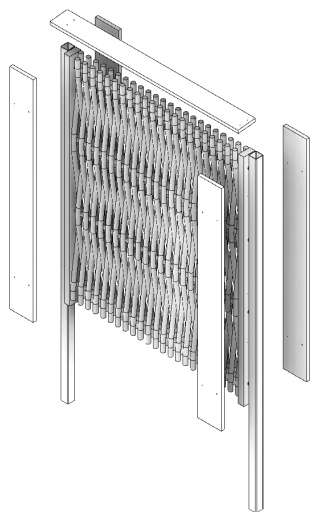

Installation steps

01 Posts installation

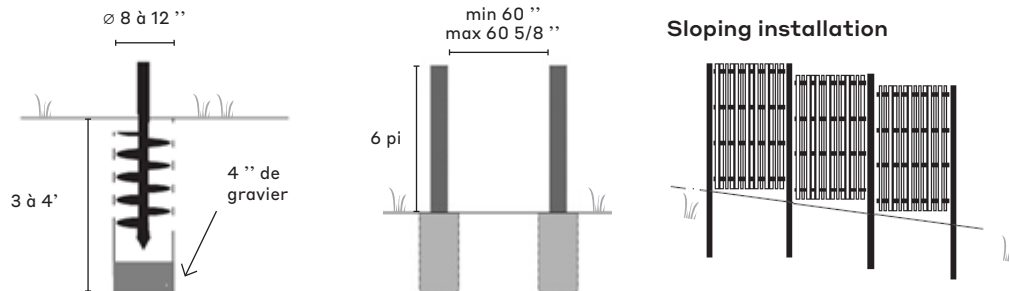

02 Panels installation

ON WOOD POSTS

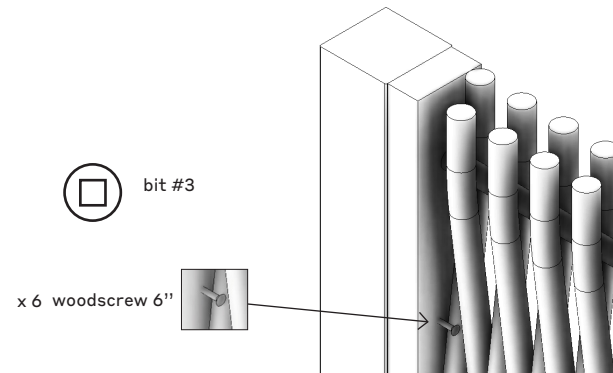
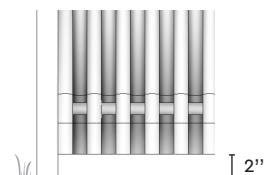

Equipment included

- Prefab willow panel 5'x6'
- Finishing plank 1"x6"X6' or 1"x6"X8 (not included)
- Selfdrilling screw 1/4"x4" (for metallic posts)
- Galvanised wood screw 3" (for wood posts)
- Galvanised woodscrew 2 1/2" (6 per plank)

INSTALLATION ON METALLIC POSTS

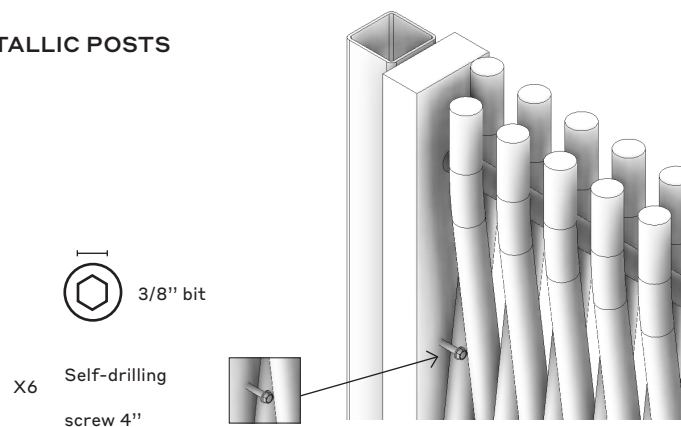

03

Finishing (optional)

The finish is the same on wood and metal posts

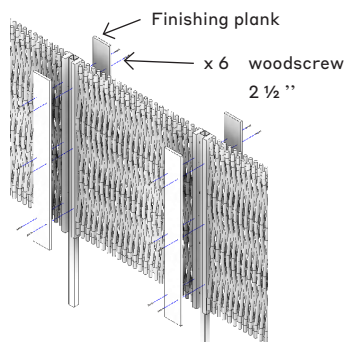

Fencing hat

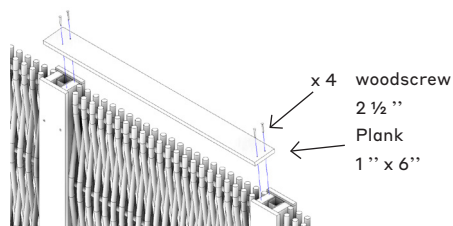

Aerial view



04

Door installation

Recommendation

Latch: D&D Technologies

Lokklatch regular

Hinges : D&D Technologies

Truclose heavy duty

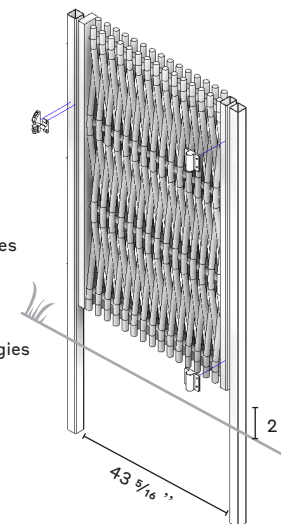

05

Shorten a panel



REMOVE THE SCREW THAT SECURES THE PIPE

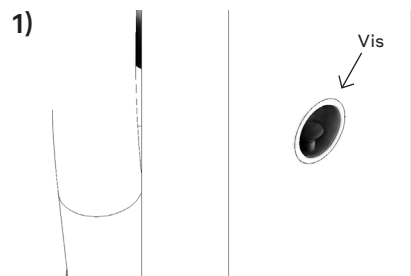

DEFINE WIDTH TO REACH

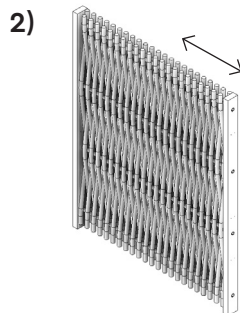

REMOVE THE NUMBER OF STEMS REQUIRED

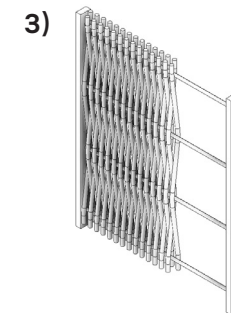

SLIDE THE FRAME

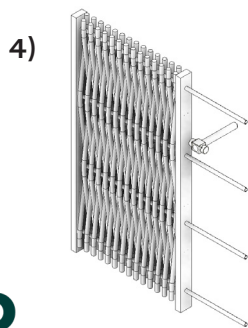

CUT THE PIPES

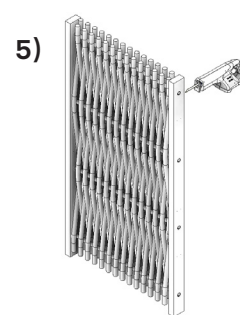

DRILL THE PIPE AND SECURE WITH A SREW

